

Series 27 Single Solenoid Pilot Inline Valves

2/2 Valves

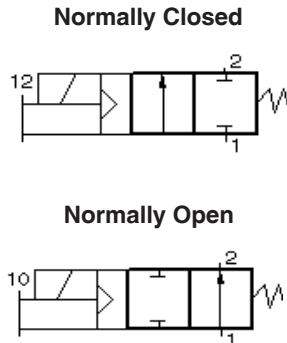
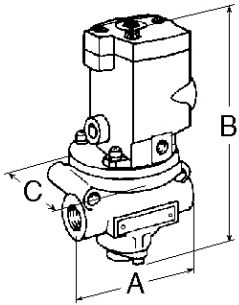

Port Size	Valve Model Numbers		Average k_v		Weight kg
	Normally Closed	Normally Open	N.C.	N.O.	
G 1/4	D2771B2001	D2772B2001	2,0	2,0	
G 3/8	D2771B3001	D2772B3001	3,3	2,9	1,1
G 1/2	D2771B4011	D2772B4011	3,5	3,1	
G 1/2	D2771B4001	D2772B4001	6,7	5,7	
G 3/4	D2771B5001	D2772B5001	7,9	6,4	1,5
G 1	D2771B6011	D2772B6011	7,9	6,9	
G 1	D2771B6001	D2772B6001	21	18	
G 1-1/4	D2771B7001	D2772B7001	25	17	3,2
G 1-1/2	D2771B8011	D2772B8011	25	18	
G 1-1/2	D2771B8001	D2772B8001	43	43	
G 2	D2771B9001	D2772B9001	50	50	6,9
G 2-1/2	D2771B9011	D2772B9011	56	63	

3/2 Valves

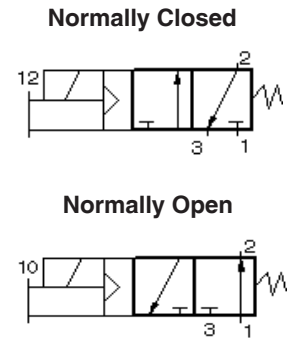
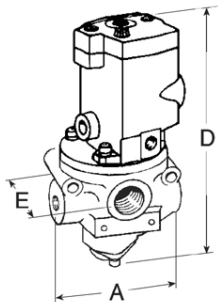

Port Sizes		Valve Model Numbers		Average k_v		Weight kg
In-Out	Exh.	Normally Closed	Normally Open	N.C.	N.O.	
G 1/4	G 1/2	D2773B2001	D2774B2001	2,4	2,2	
G 3/8	G 1/2	D2773B3001	D2774B3001	3,9	2,6	1,1
G 1/2	G 1/2	D2773B4011	D2774B4011	3,8	2,6	
G 1/2	G 1	D2773B4001	D2774B4001	6,8	6,2	
G 3/4	G 1	D2773B5001	D2774B5001	8,2	6,2	1,5
G 1	G 1	D2773B6011	D2774B6011	8,7	6,2	
G 1	G 1-1/2	D2773B6001	D2774B6001	25	18	
G 1-1/4	G 1-1/2	D2773B7001	D2774B7001	27	19	3,2
G 1-1/2	G 1-1/2	D2773B8011	D2774B8011	27	18	
G 1-1/2	G 2-1/2	D2773B8001	D2774B8001	60	51	
G 2	G 2-1/2	D2773B9001	D2774B9001	61	52	7,4
G 2-1/2	G 2-1/2	D2773B9011	D2774B9011	62	48	

4/2 Valves

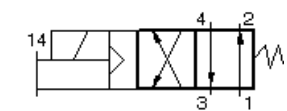
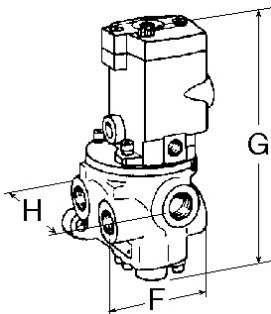

Port Sizes		Valve Model Numbers	Average k_v	Weight kg
In-Out	Exhaust			
G 1/4	G 1/2	D2776B2001	2,2	
G 3/8	G 1/2	D2776B3001	3,1	1,4
G 1/2	G 1/2	D2776B4011	3,2	
G 1/2	G 1	D2776B4001	6,0	
G 3/4	G 1	D2776B5001	7,1	2,4
G 1	G 1	D2776B6011	7,8	
G 1	G 1-1/2	D2776B6001	20	
G 1-1/4	G 1-1/2	D2776B7001	21	5,1
G 1-1/2	G 1-1/2	D2776B8011	21	

DIMENSIONS mm

Port Size	A	B	C	D	E	F	G	H
G 1/4 to G 1/2	90	175	79	181	79	99	191	99
G 1/2 to G 1	116	193	79	201	91	117	241	134
G 1 to G 1-1/2	168	263	104	263	123	165	274	211
G 1-1/2 to G 2-1/2	219	300	130	313	161	—	—	—

STANDARD SPECIFICATIONS: For valves on this page.

Solenoids: AC or DC power. See page 3 for voltages.

Power Consumption: 87 VA inrush, 30 VA holding on 50 or 60 Hz; 14 watts on DC.

Ambient Temperature: 4° to 50°C.

Media Temperature: 4° to 80°C.

Flow Media: Filtered air. 5 micron recommended.

Inlet Pressure:

G 1/4 to G 1-1/2 Port Sizes: 1 to 10 bar.

G 1-1/2 G to 2-1/2 Port Sizes: 2 to 10 bar.

Pilot Pressure: When external supply is used, pressure must be equal to or greater than inlet pressure.

Threads: BSPP. (For NPT threads, consult ROSS).

Series 27 Remote Air Pilot Inline Valves

2/2 Valves

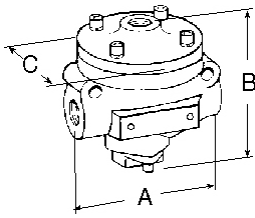

Normally Closed

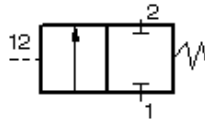

Normally Open

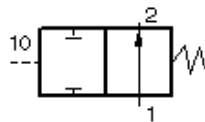

Port Size	Valve Model Numbers		Average k_v		Weight kg
	Normally Closed	Normally Open	N.C.	N.O.	
G 1/4	D2751A2001	D2752A2001	2,0	2,0	
G 3/8	D2751A3001	D2752A3001	3,3	2,9	0,6
G 1/2	D2751A4011	D2752A4011	3,5	3,1	
G 1/2	D2751A4001	D2752A4001	6,7	5,7	
G 3/4	D2751A5001	D2752A5001	7,9	6,4	0,9
G 1	D2751A6011	D2752A6011	7,9	6,9	
G 1	D2751A6001	D2752A6001	21	18	
G 1-1/4	D2751A7001	D2752A7001	25	17	3,6
G 1-1/2	D2751A8011	D2752A8011	25	18	
G 1-1/2	D2751A8001	D2752A8001	43	43	
G 2	D2751A9001	D2752A9001	50	50	6,4
G 2-1/2	D2751A9011	D2752A9011	56	63	

3/2 Valves

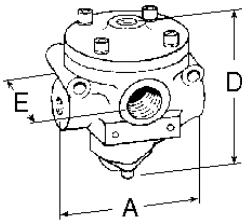

Normally Closed

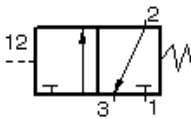

Normally Open

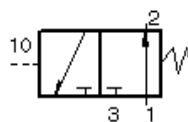

Port Sizes		Valve Model Numbers		Average k_v		Weight kg
In-Out	Exh.	Normally Closed	Normally Open	N.C.	N.O.	
G 1/4	G 1/2	D2753A2001	D2754A2001	2,4	2,2	
G 3/8	G 1/2	D2753A3001	D2754A3001	3,9	2,6	0,6
G 1/2	G 1/2	D2753A4011	D2754A4011	3,8	2,6	
G 1/2	G 1	D2753A4001	D2754A4001	6,8	6,2	
G 3/4	G 1	D2753A5001	D2754A5001	8,2	6,2	0,9
G 1	G 1	D2753A6011	D2754A6011	8,7	6,2	
G 1	G 1-1/2	D2753A6001	D2754A6001	25	18	
G 1-1/4	G 1-1/2	D2753A7001	D2754A7001	27	19	2,7
G 1-1/2	G 1-1/2	D2753A8011	D2754A8011	27	18	
G 1-1/2	G 2-1/2	D2753A8001	D2754A8001	60	51	
G 2	G 2-1/2	D2753A9001	D2754A9001	61	52	6,9
G 2-1/2	G 2-1/2	D2753A9011	D2754A9011	62	48	

4/2 Valves

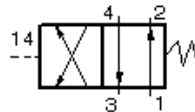
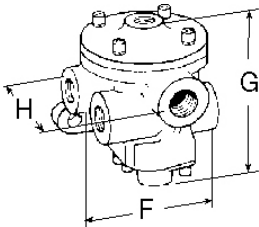

Port Sizes		Valve Model Numbers	Average k_v	Weight kg
In-Out	Exhaust			
G 1/4	G 1/2	D2756A2001	2,2	
G 3/8	G 1/2	D2756A3001	3,1	0,8
G 1/2	G 1/2	D2756A4011	3,2	
G 1/2	G 1	D2756A4001	6,0	
G 3/4	G 1	D2756A5001	7,1	1,9
G 1	G 1	D2756A6011	7,8	
G 1	G 1-1/2	D2756A6001	20	
G 1-1/4	G 1-1/2	D2756A7001	21	4,6
G 1-1/2	G 1-1/2	D2756A8011	21	

DIMENSIONS mm

Port Size	A	B	C	D	E	F	G	H
G 1/4 to G 1/2	90	94	77	101	79	99	101	99
G 1/2 to G 1	116	112	77	120	91	117	147	134
G 1 to G 1-1/2	168	188	104	188	123	165	190	211
G 1-1/2 to G 2-1/2	219	231	130	240	161	165	198	208

STANDARD SPECIFICATIONS:

For valves on this page.

Ambient/Media Temperature: 4° to 80°C.

Flow Media: Filtered air. 5 micron recommended.

Inlet Pressure:

G 1/4 to G 1-1/2 Port Sizes: 1 to 10 bar.

G 1-1/2 to G 2-1/2 Port Sizes: 2 to 10 bar.

Pilot Pressure: Must be equal to or greater than inlet pressure.

Threads: BSPP. (For NPT threads, consult ROSS).

Series 27 Double Solenoid Pilot Inline Valves

4/2 Valves

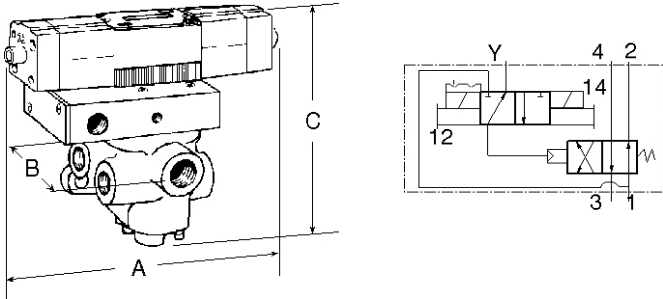

DIMENSIONS mm

Port Size	A	B	C
G 1/4 to G 1/2	239	99	201
G 1/2 to G 1	239	134	246
G 1 to G 1-1/2	239	208	295

Port Sizes		Valve Model	Average k_v	Weight kg
In-Out	Exhaust	Numbers		
G 1/4	G 1/2	D2776B2003	2,2	1,8
G 3/8	G 1/2	D2776B3003	3,1	
G 1/2	G 1/2	D2776B4013	3,2	
G 1/2	G 1	D2776B4003	6,0	2,8
G 3/4	G 1	D2776B5003	7,1	
G 1	G 1	D2776B6013	7,8	
G 1	G 1-1/2	D2776B6003	20	5,5
G 1-1/4	G 1-1/2	D2776B7003	21	
G 1-1/2	G 1-1/2	D2776B8013	21	

STANDARD SPECIFICATIONS: For valves on this page.

Solenoids: AC or DC power.

Power Consumption: Each solenoid; 190 VA inrush, 40 VA holding on 50 or 60 Hz; 20 watts on DC.

Indicator Lights: In each solenoid housing.

Ambient Temperature: 4° to 50°C.

Media Temperature: 4° to 80°C.

Flow Media: Filtered air. 5 micron recommended.

Inlet Pressure: 1 to 10 bar.

Pilot Pressure: If external supply is used, pressure must be equal to or greater than inlet pressure.

Threads: BSPP. (For NPT threads, consult ROSS).

Indicator Light Kit

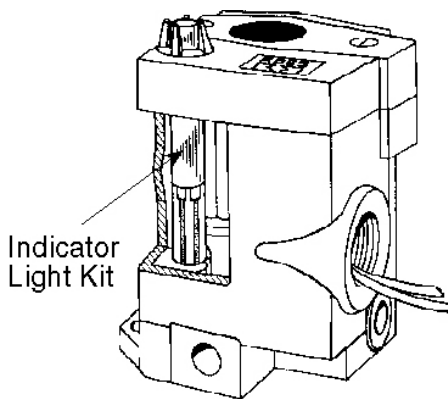

An indicator light extends through the solenoid or pilot cover and is illuminated when the solenoid is energized. Such lights are standard on double solenoid valves in Series 21 and 27.

An indicator light is available in kit form for single solenoid models in Series 16, Series 21 (type O only), and Series 27. Order kit number **862K87** and specify the voltage of the solenoid.

Manual Override Kits

Flush flexible manual overrides are standard on single solenoid models in Series 16 and Series 27. Double solenoid models in Series 21 and 27 have flush metal-button overrides. Both types are non-locking.

Each of the buttons in the override kits below is made of metal and is spring-returned. The locking type button, however, can be kept in the actuated position by turning the slot in the top of the button with a screwdriver.

Order by the kit numbers shown below.



FLUSH BUTTON

Locking type Kit **792K87**
Non-locking type..... Kit **790K87**

EXTENDED BUTTON WITH PALM ACTUATOR

Non-locking type
Kit **984H87**



EXTENDED BUTTON

Non-locking type
Kit **791K87**

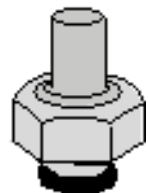

Series 21 Single Solenoid Pilot Inline Valves

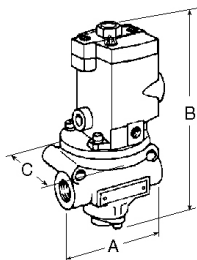

2/2 Valves

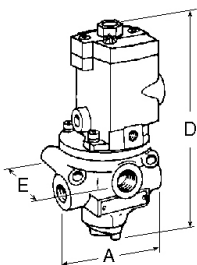

3/2 Valves

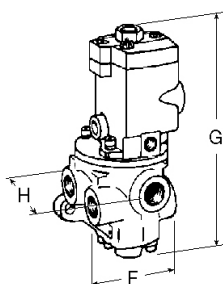

4/2 Valves

VALVE MODEL NUMBERS for TYPE H (High Temperature) SERVICE

Port Size In-Out	Exh.	2/2 Valves		3/2 Valves		4/2 Valves	Weight kg
		Normally Closed	Normally Open	Normally Closed	Normally Open		
G 1/4	G 1/2	D2171B2001	D2172B2001	D2173B2001	D2174B2001	D2176B2001	1,4
G 3/8	G 1/2	D2171B3001	D2172B3001	D2173B3001	D2174B3001	D2176B3001	
G 1/2	G 1/2	D2171B4011	D2172B4011	D2173B4011	D2174B4011	D2176B4011	
G 1/2	G 1	D2171B4001	D2172B4001	D2173B4001	D2174B4001	D2176B4001	1,5
G 3/4	G 1	D2171B5001	D2172B5001	D2173B5001	D2174B5001	D2176B5001	
G 1	G 1	D2171B6011	D2172B6011	D2173B6011	D2174B6011	D2176B6011	
G 1	G 1-1/2	D2171B6001	D2172B6001	D2173B6001	D2174B6001	D2176B6001	3,4
G 1-1/4	G 1-1/2	D2171B7001	D2172B7001	D2173B7001	D2174B7001	D2176B7001	
G 1-1/2	G 1-1/2	D2171B8011	D2172B8011	D2173B8011	D2174B8011	D2176B8011	

VALVE MODEL NUMBERS for TYPE O (Low Temperature) SERVICE

Port Size In-Out	Exh.	2/2 Valves		3/2 Valves		4/2 Valves	Weight kg
		Normally Closed	Normally Open	Normally Closed	Normally Open		
G 1/4	G 1/2	D2171B2002	D2172B2002	D2173B2002	D2174B2002	D2176B2002	1,4
G 3/8	G 1/2	D2171B3002	D2172B3002	D2173B3002	D2174B3002	D2176B3002	
G 1/2	G 1/2	D2171B4012	D2172B4012	D2173B4012	D2174B4012	D2176B4012	
G 1/2	G 1	D2171B4002	D2172B4002	D2173B4002	D2174B4002	D2176B4002	2,6
G 3/4	G 1	D2171B5002	D2172B5002	D2173B5002	D2174B5002	D2176B5002	
G 1	G 1	D2171B6012	D2172B6012	D2173B6012	D2174B6012	D2176B6012	
G 1	G 1-1/2	D2171B6002	D2172B6002	D2173B6002	D2174B6002	D2176B6002	5,4
G 1-1/4	G 1-1/2	D2171B7002	D2172B7002	D2173B7002	D2174B7002	D2176B7002	
G 1-1/2	G 1-1/2	D2171B8012	D2172B8012	D2173B8012	D2174B8012	D2176B8012	

DIMENSIONS mm

Port Size	A	B	C	D	E	F	G	H
G 1/4 to G 1/2	90	178	76	186	92	97	196	99
G 1/2 to G 1	116	196	76	203	117	132	246	104
G 1 to G 1-1/2	168	266	104	266	168	208	282	165

STANDARD SPECIFICATIONS: For valves on this page.

Solenoids: AC or DC power.

Power Consumption: 87 VA inrush, 30 VA holding on 50 or 60 Hz; 14 watts on DC.

Manual Override: Non-locking metal button.

Ambient Temperature: *Type H:* -17° to 122°C.

Type O: -40° to 50°C.

Media Temperature: *Type H:* -17° to 150°C.

Type O: -40° to 80°C.

For temperatures below 4°C air must be free of water vapor to prevent formation of ice.

Flow Media: Filtered air. 5 micron recommended.

Inlet Pressure: 2 to 10 bar.

Pilot Pressure: When external supply is used, pressure must be equal to or greater than inlet pressure.

Threads: BSPP. (For NPT threads, consult ROSS).

Average k_v : Ratings see corresponding Series D27.

Series 21 Pressure Controlled Inline Valves

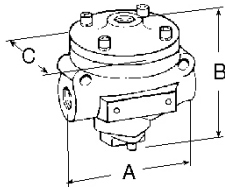

2/2 Valves

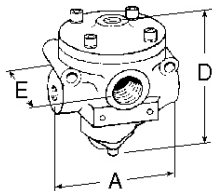

3/2 Valves

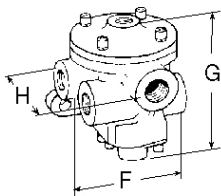

4/2 Valves

VALVE MODEL NUMBERS for TYPE H (High Temperature) SERVICE

Port Size		2/2 Valves		3/2 Valves		4/2 Valves	Weight (kg)
In-Out	Exh.	Normally Closed	Normally Open	Normally Closed	Normally Open		
G 1/4	G 1/2	D2151B2001	D2152B2001	D2153B2001	D2154B2001	D2156B2001	0,8
G 3/8	G 1/2	D2151B3001	D2152B3001	D2153B3001	D2154B3001	D2156B3001	
G 1/2	G 1/2	D2151B4011	D2152B4011	D2153B4011	D2154B4011	D2156B4011	
G 1/2	G 1	D2151B4001	D2152B4001	D2153B4001	D2154B4001	D2156B4001	2,0
G 3/4	G 1	D2151B5001	D2152B5001	D2153B5001	D2154B5001	D2156B5001	
G 1	G 1	D2151B6011	D2152B6011	D2153B6011	D2154B6011	D2156B6011	
G 1	G 1-1/2	D2151B6001	D2152B6001	D2153B6001	D2154B6001	D2156B6001	5,0
G 1-1/4	G 1-1/2	D2151B7001	D2152B7001	D2153B7001	D2154B7001	D2156B7001	
G 1-1/2	G 1-1/2	D2151B8011	D2152B8011	D2153B8011	D2154B8011	D2156B8011	

VALVE MODEL NUMBERS for TYPE O (Low Temperature) SERVICE

Port Size		2/2 Valves		3/2 Valves		4/2 Valves	Weight (kg)
In-Out	Exh.	Normally Closed	Normally Open	Normally Closed	Normally Open		
G 1/4	G 1/2	D2151B2002	D2152B2002	D2153B2002	D2154B2002	D2156B2002	0,8
G 3/8	G 1/2	D2151B3002	D2152B3002	D2153B3002	D2154B3002	D2156B3002	
G 1/2	G 1/2	D2151B4012	D2152B4012	D2153B4012	D2154B4012	D2156B4012	
G 1/2	G 1	D2151B4002	D2152B4002	D2153B4002	D2154B4002	D2156B4002	2,0
G 3/4	G 1	D2151B5002	D2152B5002	D2153B5002	D2154B5002	D2156B5002	
G 1	G 1	D2151B6012	D2152B6012	D2153B6012	D2154B6012	D2156B6012	
G 1	G 1-1/2	D2151B6002	D2152B6002	D2153B6002	D2154B6002	D2156B6002	5,0
G 1-1/4	G 1-1/2	D2151B7002	D2152B7002	D2153B7002	D2154B7002	D2156B7002	
G 1-1/2	G 1-1/2	D2151B8012	D2152B8012	D2153B8012	D2154B8012	D2156B8012	

DIMENSIONS mm

Port Size	A	B	C	D	E	F	G	H
G 1/4 to G 1/2	90	94	77	101	79	99	101	99
G 1/2 to G 1	116	112	77	120	91	117	147	134
G 1 to G 1-1/2	168	190	104	190	123	165	190	211

STANDARD SPECIFICATIONS: For valves on this page.

Ambient/Media Temperatures:

Type H: -17° to 150°C.

Type O: -40° to 80°C.

For temperatures below 4°C air must be free of water vapor to prevent formation of ice.

Flow Media: Filtered air. 5 micron recommended.

Inlet Pressure: 2 to 10 bar.

Pilot Pressure: Must be equal to or greater than inlet pressure.

Threads: BSP. (For NPT threads, consulting ROSS).

Average k_v ratings see corresponding Series D27 models.